

PUMP OPERATION MANUAL

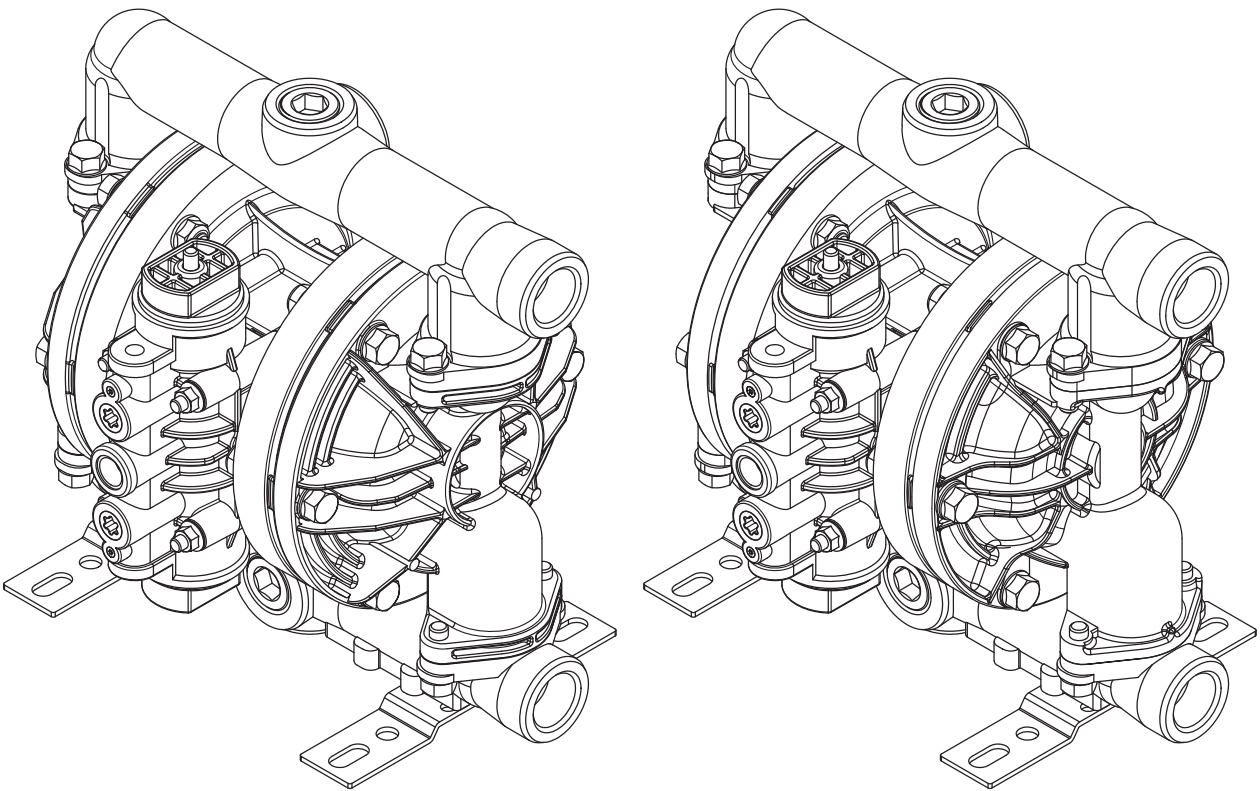

For safety purposes please be sure to read and follow the instructions contained within this manual before pump installation and operation.

TC-X203A(-PC) TC-X203S(-PC)

Series Pumps

Introduction

Thank you for Purchasing this our company Air Operated Double Diaphragm Pump. Diaphragm Pumps fall under the positive-displacement pump category. They are powered by compressed air and transfer liquids through the movement of 2 diaphragms connected by a center shaft. The pump runs through the use of an air switching mechanism which diverts air to each diaphragm in turn on a continuous fashion. Depending on the liquid to be transferred, pumps are available in a variety of body materials including; aluminum, stainless steel, cast iron, polypropylene, polyvinylidene fluoride. The diaphragms and valves within the pump are also available in various rubber, plastic and thermoplastic elastomers each with its own chemical resistance properties.

Table of contents

Introduction.....	1
Important Items.....	2
For safe operation.....	2
For safety	3 ~ 5
Product information.....	6 ~ 9
1.Specifications.....	6
2.Accessories included with the pump	6
3.Names of parts and materials.....	7
4.Dimensions.....	8
5.Performance curves.....	9
Installation	10 ~ 13
1.Installing and connecting the pump.....	10
2.Recommended liquid piping connection diagram.....	12
3.Recommended air piping connection diagram.....	13
Operation	14 ~ 15
1.Pump start up.....	14
2.Liquid flow adjustments.....	14
3.Stopping the Pump.....	14
4.Releasing pressure	15
5.Method of cleaning the pump.....	15
Maintenance.....	16 ~ 20
Daily Maintenance checks	16
Troubleshooting.....	17
Limited Factory Warranty	21

While pump is in operation do not cover the liquid inlet port with your hand or any another part of your body.

If the pump has remained unused for a long period or if you have any kind of misgivings about running the pump please consult with your local our company distributor or contact our company directly.

Important Items

For safe operation

- Before using the pump, be sure to read this document carefully, particularly the “warnings and cautions,” and be fully familiar with the correct operating procedures.

- Within this document all the warnings and cautions will be indicated by the following symbols.



WARNING

If you ignore the warning described and operate the product in an improper manner, there is danger of serious bodily injury or death.



CAUTION

If you ignore the caution described and operate the product in an improper manner, there is danger of personal injury or property damage.

Furthermore, to indicate the type of danger and damage, the following symbols are also used along with those mentioned above:



This symbol indicates a DON'T, and will be accompanied by an explanation on something you must not do.







This symbol indicates a DO, and will be accompanied by instructions on something you must do in a certain situation.



This symbol indicates important information is contained here.



For safety

WARNING

-  · When using compressed gas (hereinafter referred to as “compressed air”) to drive this pump, be sure it is one of the following:
 - 1) Compressed air supplied from an air compressor
(To drive this product, use supply air with a minimum moisture content.)
 - 2) Nitrogen (N₂) gasThe use of compressed air other than those mentioned above may cause air pollution, damage to the pump, or even an explosion.
-  · Pressure Ratings are dependent on pump material and liquid temperature variations. Please see the “Liquid Temperature Correlation Graph” in the [5. Performance curves] and check for the allowable working pressure at the specific temperature of the liquid being pumped. Air pressure and discharge pressure must not exceed the allowable working pressure. If air pressure and discharge pressure exceed the allowable working pressure, it may cause liquid leaks, damage to the pump casings or diaphragms and could cause a fatal accident.
-  · Before moving this product, make sure that the internal pressure is released. If the pump is moved while under pressure, any shock imparted by knocking or dropping the pump etc. may damage the pump or even cause an explosion.
-  · Improper electrical grounding, poor ventilation, or unshielded fire or spark can create a danger of fire or explosion. Therefore, the following precautions are strongly advised.
 - * All peripheral equipment and piping connected to this product should be properly grounded.
 - * To pump flammable liquids, use a model with a conductive aluminum or stainless-steel casing.
 - * Whenever you notice any spark while operating this product, immediately stop its operation, and do NOT start using it again unless you are sure of the cause and corrective actions have been taken out.
 - * Depending upon the type of fluid being pumped, bubbles of flammable gas may be generated. Make sure that ventilation is satisfactory.
 - * This product itself, its piping and exhaust ports should be kept away from unshielded fire, spark and other causes of ignition. If a diaphragm is damaged, fluid may gush out together with air from the exhaust port.
 - * Do NOT leave gasoline or solvent etc. that contains waste at the work site.
 - * Machinery and other equipment near the place of installation of this product should be properly insulated to prevent electrical conduction with each other.
 - * Do NOT operate heating devices naked flames or have heating filaments anywhere near the pump or its piping.
 - * If there are flammable gases in the immediate atmosphere while the pump is operating, do NOT switch electric appliance on and off.
 - * Do NOT operate gasoline engines around the pump work site.
 - * Restrict smoking around the pump work site.





For safety

WARNING

-  · Before using this product, be sure you are familiar with the precautions regarding the fluid to be pumped, and verify the corrosion resistance of the parts that will come into contact with the fluid (wetted parts). NEVER use the product with any fluid against which it does not have sufficient corrosion resistance or with a fluid that poses a risk of explosion. If you are unsure of the corrosion resistance, contact your nearest distributor or our company directly. If you use this product with any fluid against which the parts that will come in contact with the fluid do not have sufficient corrosion resistance, it may result in damaging the product or leakage of fluid or pump failure.
-  · When using this product, observe local relevant regulatory rules concerning transfer and storage of chemicals, fire prevention, labor safety standards, etc.
-  · Hazardous fluids (such as strong acid or alkali, flammable or toxic liquids) or gas bubbles generated by such fluids may cause serious injury or even death if accidentally inhaled or consumed or if they come into contact with the eyes or adhere to the skin. Therefore, the following precautions are strongly advised.
 - * Be fully familiar with the properties of the fluid to be pumped and work in strict accordance with the operating instructions provided by the suppliers of such fluids (such as wearing goggles, gloves, mask or protective work clothes).
 - * When storing a hazardous fluid, strictly comply with the regulatory procedures (such as using proper containers, storage conditions, etc.).
 - * Always install the piping and exhaust port of this pump away from areas frequented by human and animal traffic.

For safety

CAUTION

-  If a diaphragm of this product is damaged, the supplied air may mix with the fluid or the fluid may flow into the main body (air-switching portion). If the air supply is inadequate or the pump is contaminated, do NOT operate the pump.
-  After you shut down the pump and disconnect the piping, some fluid may still be remaining inside the pump. Also, if the pump is left unused for a prolonged period, some fluid may remain inside the pump and within the connected piping. Therefore, be sure to purge the system of fluid and clean the pump before prolonged disuse or storage. If the product is left unused for a prolonged period with fluid remaining in the connected piping as well as the pump itself, the fluid may expand, depending on the ambient temperature (because of freezing or heat), which may cause damage to the pump and/or piping and possible leakage of fluid.
-  The Pumps Non wetted parts are made from various materials and are not designed to withstand corrosive chemicals. Therefore there is a possibility of damage to the pumps non wetted parts through leaks or breakage of the diaphragm as well as liquid or gas permeation through the actual diaphragm material. There is also a possibility of damage due to chemical fumes in the local environment or fumes entering into the air line through the compressor. It is also possible to damage these components when incorrect lubrication is used. To help prevent any unnecessary damage please follow the following precautions. Ventilation of the local environment, remove liquids when the pump is not in use. (Long term). Open ventilation of the switching area of pump. Clean and flush the pumps air switching section if a leak or diaphragm breakage occurs.
-  For safe transport be sure to prevent liquid leaking from pump for safe transport.
It is the end-users responsibility to thoroughly wash and clean the pump(s) to prevent accidents caused by liquid leaks.
-  Always use genuine parts when replacing component parts of this product. Do not attempt to modify the components parts or replace them with anything other than genuine parts.

Product information

1.Specifications

Model	TC-X203 <input type="checkbox"/> [NPT]	
	A <input type="checkbox"/> , S <input type="checkbox"/>	AT , ST
Liquid port	Rc 3/4 [NPT 3/4]	
Material · Weight	Table 1	
Operating pressure ※ 1	0.2 ~ 0.7 MPa [30-100 psi]	
Max discharge pressure	0.7 MPa [100 psi]	
Discharge volume/Cycle	800 mL	650 mL
Max Discharge volume	200 L/min [52.8 Gallon/min]	190 L/min [50.2 Gallon/min]
Max air consumption	1600 L/min(ANR) [56.5 SCFM]	1600 L/min(ANR) [56.5 SCFM]
Max solid size	6.5 mm or less	
Limitation of viscosity	Self-priming 3 Pa · s or less Force In 8Pa · s or less	
Ambient temperatur	0 ~ 70 °C [32-158 °F]	
Liquid temperatur	0 ~ 70 °C [32-158 °F]	
Dimensions	Table 2	
A-Weighted sound pressur level ※ 2	81dB	
A-Weighted sound power level ※ 3	92dB	

※ 1 The maximum applied air pressure of the plastic pump depends on the liquid temperature. (Table 3)





※ 2 Measurement method of A-weighted sound pressure level is based on ISO 1996.

※ 3 Measurement method of A-weighted sound power level is based on ISO 3744.

2.Accessories included with the pump

- Pump Operation Manual.....1
- Service Book.....1
- How to use the Service Book.....1
- Parts list1
- Pump.....1
- Airline ball valve1
- Silencer.....1
- Base.....2
- Bolt (M8 × 12).....2

CAUTION

-  After delivery open the product packaging and check to make sure that all included accessories are present and in good order.
-  Remember that the pump is heavy, so extreme care must be taken when lifting it. When lifting the pump using a chain hoist or crane, be sure to lift the pump by the specified lift point(s).
-  When installing the accessories, please use the pipe sealing tape as provided for each threaded position. Also take care that broken or shredded pipe sealing tape does not contaminate the liquid or Air inlets. Note that a contaminated airline may cause failure of the pumps air switching unit.
-  Please install the air inlet Airline ball valve by referring to [Outside view] of [3.Name of parts and materials].
-  Please install Liquid inlet/outlet plugs to discharge and suction ports as required and refer to [Outside view] of [3.Name of parts and materials].

Product information

3.Names of parts and materials

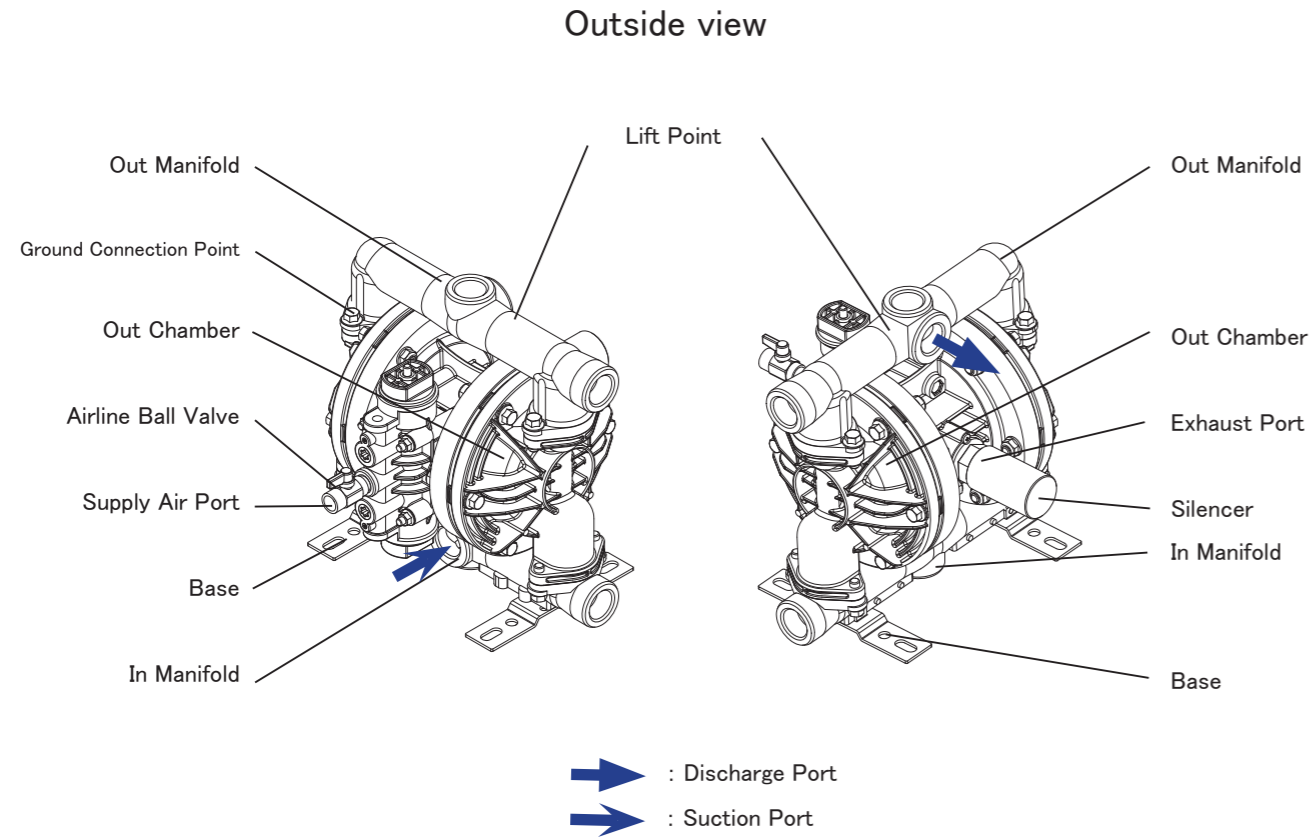

Material and weight

MODEL	203AC	203AN	203AE	203AV	203AT	203AH	203AS	203SC	203SN	203SE	203SV	203ST	203SH	203SS
Pump Wetted Parts	ADC12・AC4C							SCS14						
Diaphragm	CR	NBR	EPDM	FKM	PTFE	TPEE	TPO	CR	NBR	EPDM	FKM	PTFE	TPEE	TPO
Valve Stopper	SCS14							SCS14						
Ball Valve	CR	NBR	EPDM	FKM	PTFE	NBR	EPDM	CR	NBR	EPDM	FKM	PTFE	NBR	EPDM
Valve Seat	CR	NBR	EPDM	FKM	PTFE	NBR	EPDM	CR	NBR	EPDM	FKM	PTFE	NBR	EPDM
Center Disk	SUS316							SUS316						
Weight	10.5 kg [23.1 lbs]							20.0 kg [44.1 lbs]						

Table 1

Product information

4.Dimensions

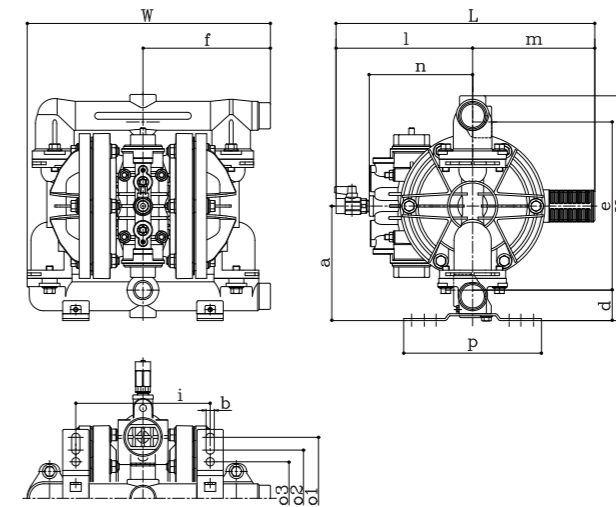

MODEL	H	W	L	a	b	d	e	f	i	l	m	n	o1	o2	o3	p	AIR INLET	AIR EXHAUST	LIQUID IN/OUT
203A □	326 [12.83]	353	375	165	12	44	244 [9.61]	185	195	198	177	150	177	140	106	200	Rc3/8	Rc3/4	Rc3/4
203S □	324 [12.76]	[13.90]	[14.76]	[6.50]	[0.47]	[1.73]	242 [9.53]	[7.28]	[7.68]	[7.80]	[6.97]	[5.91]	[6.97]	[5.51]	[4.17]	[7.87]	[NPT3/8]	[NPT3/4]	[NPT3/4]

(Measure : mm [inch])

Table 2

Product information

5. Performance curves

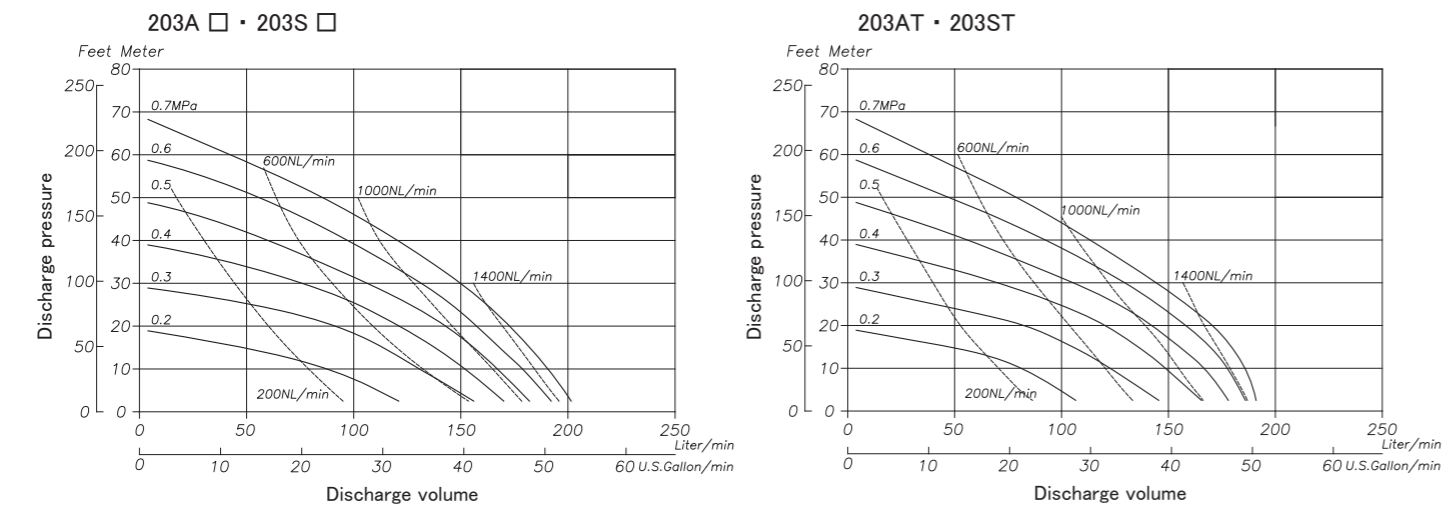

----- Air consumption
 ——— Performance curve



NOTICE

The maximum safe working pressure of the pump depends on the liquid temperature. Always refer to this liquid temperature correlation chart when determining the correct air pressure.

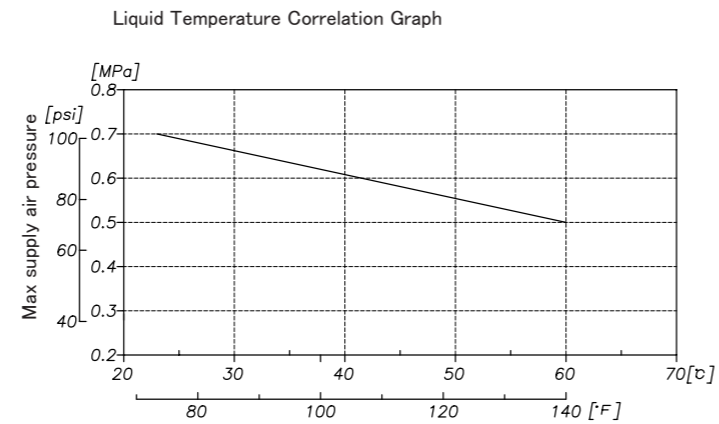

Liquid TEMP.

Table 3



NOTICE

This is the measurement method used when determining the pumps performance curves. Please refer to the below measurement instruments and testing procedure.

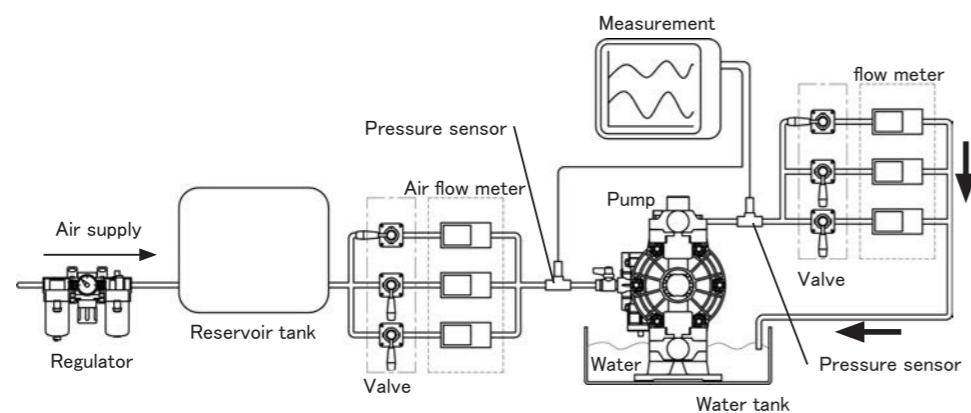

Measurement equipment and piping layout diagram

Liquid pumped: Fresh water
 Temperature: Ambient
 Condition of suction:
 Flat suction 0 meter [0 ft] head

Installation

1. Installing and connecting the pump

Decide where the pump should be installed and secure a suitable space (see Examples of installations A to D).

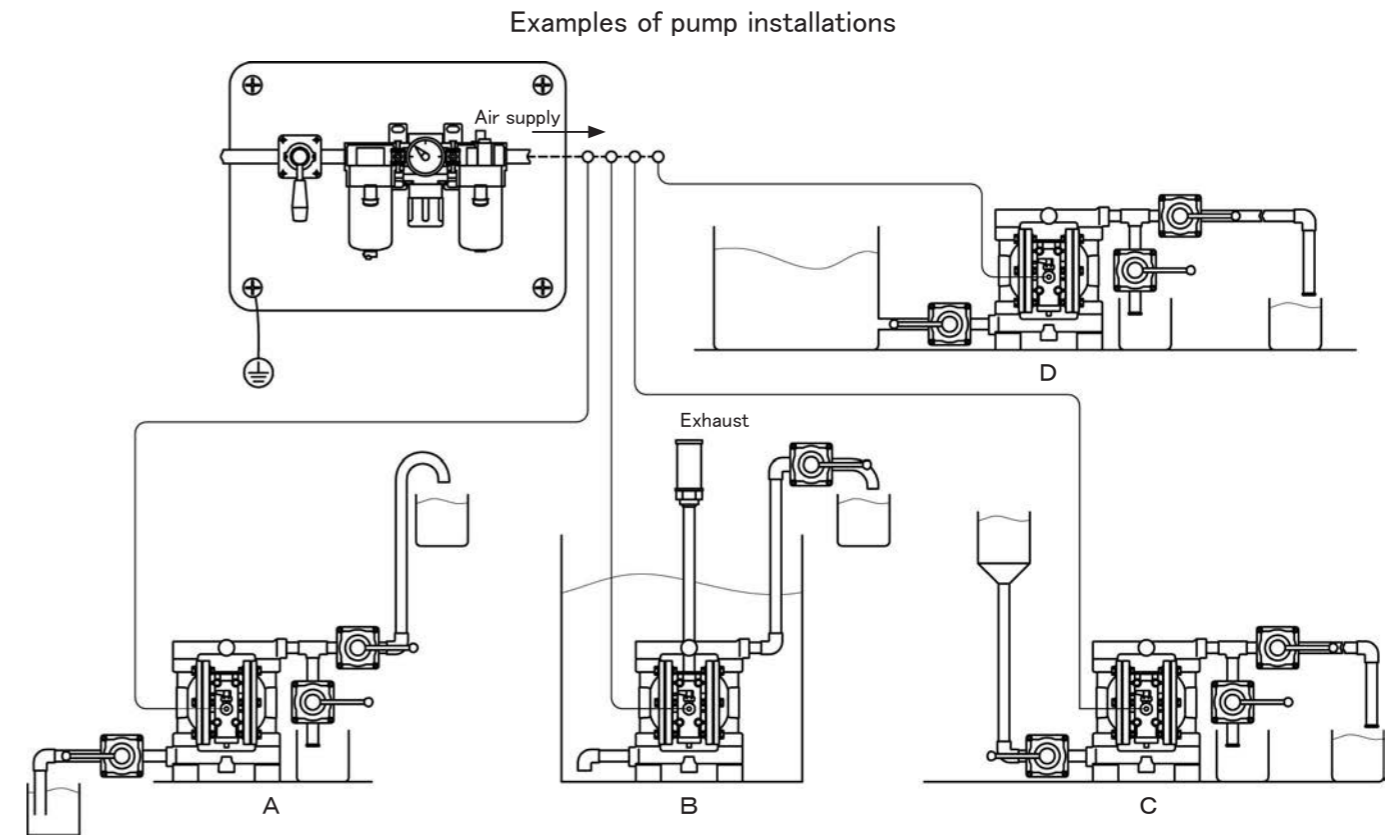

For optimal performance try to keep the suction lift as short as possible.

To protect the diaphragms from abnormal damage or breakage, the inlet pressure must be kept below the following values:

- ※ PTFE Diaphragms : 0.02 MPa [3 psi] (height 2 m [6.6 ft]) During operation
 : 0.05 MPa [7 psi] (height 5 m [16.4ft]) When not in operation
- ※ All other Diaphragms : 0.1MPa [14 psi] (height 10 m [32.8ft])

(The above values are when transferring fresh water under ambient temperature. Depending on the liquid these values may change.)

When installing the pump, please use a method that allows the pump to absorb vibration caused during pump operation.

Installation

CAUTION

- If the pump will be submerged into the liquid during operation, follow the steps below:
 - * Verify the corrosion resistance of each component of the pump, and do NOT expose the pump to any fluid for which it does not have proper corrosion resistance.
 - * The exhaust should be redirected outside, not into the fluid in which the pump is submerged. For information on how to arrange the exhaust, see [Arranging outside exhaust] below.
- When operating the pump, operational noise will be generated, and the level will depend upon the following conditions of use (type of fluid being pumped, the supply air pressure and liquid discharge pressure). If there are specific regulatory sound level rules that apply to your country or region, provide appropriate acoustic counter measures. (For the noise levels of this product, see [1. Specifications].)
- When airline operation is to be controlled by a solenoid valve, then a three way type valve is recommended. A three-way solenoid valve allows any trapped air to bleed off, in turn improving pump performance.
- Use a flexible hose between the pump and hard piping to absorb pump or pipe vibration, and ground the hose.
- Make sure that there is no external mechanical force or pressure applied to any connections of the pump. Be especially careful not to allow the pump to support part of the weight of the hose or the piping. If you use a hose of small inner diameter, the pump's performance may be adversely affected, and it may even malfunction.
- When moving the pump, make sure that the pump will not fall. NEVER try to move the pump by pulling the hoses connected to the pump. Either the hose or the pump may be damaged.
- Before starting the pump, make sure that all the bolts are securely tightened/re-torqued. (Refer to the Service Book for the correct bolt torque values.)
- If you use the pump intermittently the pump will not require lubrication. However lubrication is recommended if running the pump continuously for long periods or using very dry air or at high temperatures. This will guarantee the life of the pumps seals.

If you decide to use a lubricator, please use only turbine oil, Class 1 (equivalent to ISO VG32).

NOTICE

- * High temperature operation: When transferring liquids whose temperature exceeds 70°C [158 °F]
- * Continuous operation: When the pump operates continuously for longer than 1 hour and is stopped for less than 15 minutes.
- * Lubrication: Use only turbine oil Class 1 (equivalent to ISO VG 32), under the following conditions;

Oil concentration at 50mg/m³, Absolute pressure at 0.1MPa [14psi]. Maximum temperature of 20°C [68 °F] and Humidity at 65%.

Installation

WARNING

- If a diaphragm is damaged, fluid may be ejected along with the air from the exhaust port. In cases when the pump is positioned below the liquid so that hydraulic pressure is acting on the pump, pushing the diaphragms etc, if a diaphragm fails then fluid can flow out of the pump under gravity. Please carryout protective measures, for example, place the pump in a pit, or set the pump into a protection box, use liquid detection through the use of a spill sensor, etc, and at the same time, provide visible warnings signs around the pump.
 - * Pump exhaust should be directed to a safe place, away from people, animals and food.
 - * Connect a hose with an electrical ground wire to the pump's exhaust port, and attach the silencer to the end of the hose. Use a hose of the same diameter as the exhaust port. (If the hose is longer than 5 meters [16.4 feet] , consult your local distributor or our company directly.) Place the exhaust outlet in a pit, or a protection box, etc.

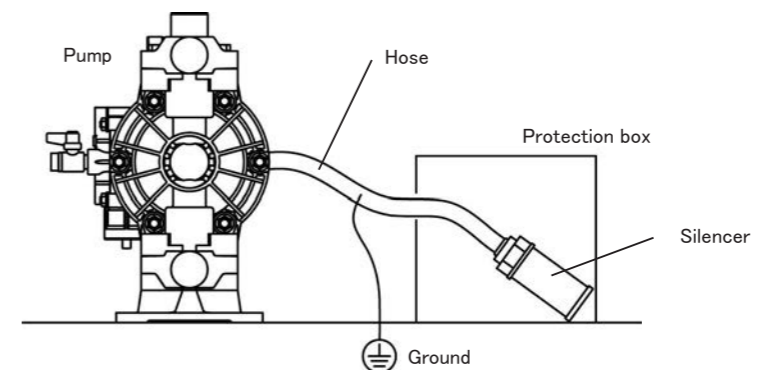

Arranging outside exhaust

2. Recommended Liquid piping connection diagram

- 1) Connect a flow valve and a drain valve to the liquid discharge side (outlet) of the pump.
- 2) Connect a flow valve for maintenance purposes to the suction side (inlet) of the pump.
- 3) Connect hoses to both the suction side and to the discharge side of the pump and attach them to the respective vessels.

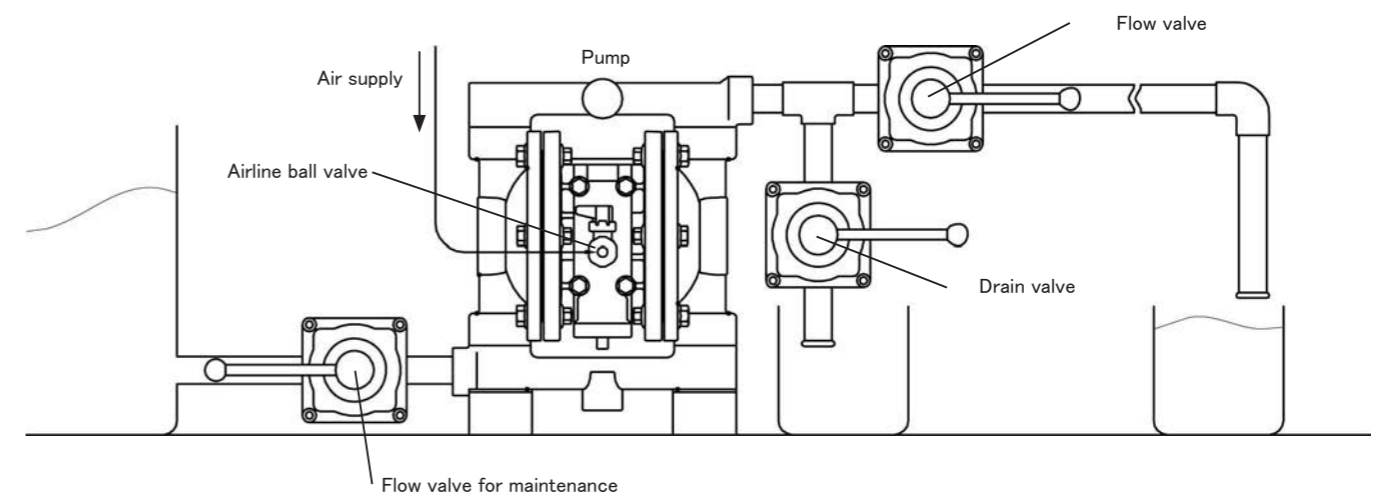

Installation

CAUTION

- ! When fitting liquid hoses to the pump, make sure to use a sturdy hose that will not collapse when strong suction pressure is applied from the pump. Also make sure the hose has a sufficient pressure rating to cope with the required discharge pressure.
- ! When pumping a fluid that contains slurry, verify that the particle size is below the Max solid size (see [1.Specifications]). If it exceeds the limitation of slurries indicated in the main specifications, attach a strainer to the pump to stop larger particles. Otherwise, such particles may cause a malfunction.
- ! Depending upon changes in pumping conditions such as expanding liquids or changes in liquid temperature the pressure inside the pump could change drastically. In such cases install a relief valve on the liquid discharge side, to bring the pressure down below the maximum permissible value.
- ! When testing piping for leakage, do NOT apply pressure to the pump's inlet and outlet sides with compressed air from outside. It may cause abnormal breakage to the diaphragm or the switching portion.
- ! When installing a standby pump or two pumps in parallel, be sure to provide a Flow valve on each of the IN and OUT liquid material manifolds and perform pump switchovers by firstly shutting off both pumps and separating them through the liquid material valves. If a Liquid line valve of the stopped pump remains open, the diaphragms could be inverted or stretched and possibly broken by the discharge pressure produced by the operating pump, thus resulting in damage in an early stage.

3.Recommended air piping connection diagram

- Connect an air valve, air filter, regulator and if necessary a lubricator (Make sure they are rated to provide sufficient air volume passage as required to run the pump correctly) Connect hoses to the pump and compressor.

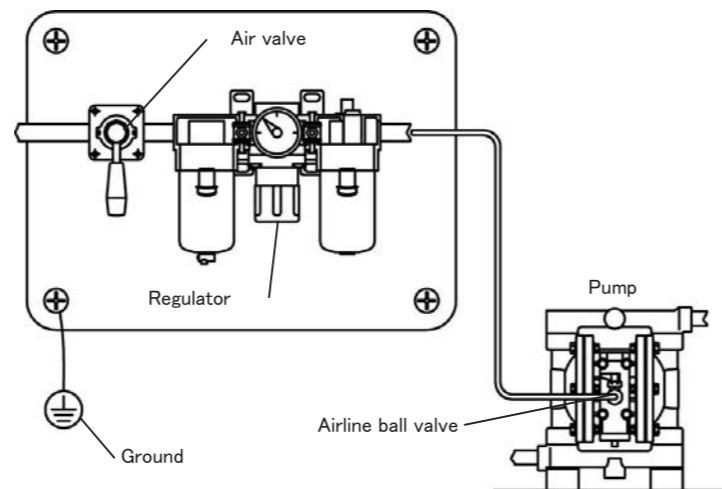

CAUTION

- ! The piping and the peripheral equipment may become clogged with foreign matter such as dust dirt or sludge. Clean the inside of the piping for 10 to 20 seconds before connecting it to the pump.

Operation

1.Pump start up

- 1) Open the air valve in front of each piece of peripheral equipment, and adjust the supply air pressure with a regulator to within the permissible range.
- 2) Open the flow valve on the discharge side.
- 3) Press the RESET BUTTON, and then slowly open the air valve of the pump.
- 4) Before allowing the pump to run at full pressure, first, verify that the pump is primed and fluid is flowing inside the piping and is being pumped to the discharge side, and then fully open the air valve.

WARNING

- 💡 If air pressure and discharge pressure exceed the allowable working pressure, it may cause liquid leaks, damaged pump casings or diaphragms and could cause a fatal accident.

2.Liquid flow adjustments

- Adjust the flow valve on the discharge side. To see the relationship between the flow rate, supply air pressure and discharge pressure, see [Performance curves].

CAUTION

- ! As you start closing the liquid discharge flow valve, the supplied air pressure may rise. Make sure that the pressure is kept within the normal operating range.
- ! Depending upon the viscosity and specific gravity of the fluid, the suction stroke and other conditions, the permissible suction flow speed of fluid into the pump will vary; however, if the pump speed (flow speed of fluid) increases greatly, cavitation could occur, and this will not only reduce pump performance, but it may cause a malfunction. To prevent cavitation adjust the supply air pressure as well as the Discharge flow valve.
- ! If fluid is not discharged after you start the pump, or if you hear an abnormal noise or notice any irregularity, shut down the pump immediately (see [Troubleshooting]).

3.Stopping the Pump

- Close the air valve of the pump and shut off the supplied air.

CAUTION

- 💡 It is permissible to shut down the pump by closing the liquid discharge flow valve even while air is still being supplied to the pump. However, if this condition continues for a long period without supervision, the pump may start running if there is a leak from the pump or piping, and therefore fluid may continue flowing out of the position of leakage.

Operation

CAUTION



- When the pump is shut down while pumping liquids containing slurry, particulate slurry matter contained in the liquid can settle and become deposited inside the bottom of the liquid chambers. If the pump is started again in the condition, the diaphragm may be damaged or the center disk may be overloaded, and this may cause damage such as bending or breaking of the center disk or center rod. As a counter measure, after finishing work, it is recommended to purge the remaining fluid and slurry particulate from the pump.

4. Releasing pressure

- 1) Make sure that the airline ball valve of the pump is closed.
- 2) Close the valve on the air-supply side of the peripheral equipment.
- 3) Close the flow valve on the discharge side, start opening the drain valve slowly, and discharge the pressurized fluid.
- 4) Open the airline ball valve of the pump, and run the pump until all the remaining pressurized air and liquid inside the pump is expelled.

CAUTION



- Fluid under pressure will gush out as soon as you open the valve, so take extreme care.

5. Method of cleaning the pump

WARNING



- Before starting operation, make sure that the pump is not pressurized.



- Be careful when removing any piping from the pump as any remaining fluid may gush out.

- 1) Remove the inlet hose from the suction side of the pump.
- 2) Close the flow valve on the discharge side, open the drain valve, and then operate a pump by opening the air pressure valve for a while to discharge any fluid remaining inside the pump.
- 3) Remove the outlet hose from the discharge side, and attach different hoses to the suction side and the discharge side for cleaning purposes.
- 4) Prepare a vessel with cleaning solution, select a cleaning solution which is appropriate for the type of fluid being pumped, and then connect the suction-side and the discharge-side hoses to the pump.
- 5) Operate the pump by starting the air pressure slowly, and let the cleaning solution circulate for a sufficient period to thoroughly clean the pump. (Finally, flush the pump with clean water.)
- 6) Remove the hose from the suction side of the pump, run the pump for a while and purge the pump of all remaining fluid.
- 7) After flushing with clean water, turn the pump upside-down to drain out any remaining water contained in the pump.

Maintenance

• Daily maintenance checks

- A) Make sure the air filter drain is empty and working correctly.
- B) When using a lubricator, verify that the quantity of lubricating oil is sufficient.
- C) Make sure that there is no leakage of fluid from any hose connections or the pump body.
- D) Check that all the bolts have the correct torque value.
- E) Make sure that there are no cracks in the pump casing or piping.
- F) Make sure that the pipe connections are not loose.
- G) Make sure that high wear parts have not past their life expectancy. Replace such parts at regular intervals. For details, refer to the Service Book.

Some special tools can help when disassembling and reassembling the pump. Please contact your local distributor or our company directly.

Maintenance

Troubleshooting

Problem	Probable Cause	Actions to be taken
Pump does not run	The exhaust port (silencer) of pump is clogged with Dirt or sludge.	Check and clean the exhaust port or replace the silencer.
	Air is not supplied	Start the compressor, open the airline ball valve and air Regulator. Check functionality of solenoid valves (if fitted).
	The supplied air pressure is too low	Raise the supplied air pressure to the pump. Check the compressor and regulator settings and check that the configuration of the air piping is correct.
	The spool stopped in neutral position	Press the RESET button.
Pump runs, but fluid does not come out or flow decreased, or stop.	The suction lift or discharge head is too long	Confirm the piping configuration and shorten the length.
	The suction-side fluid piping (including the strainer) is clogged with slurry or sludge	Check and clean the fluid piping and filters (if fitted).
	The supply air pressure is low	Raise the supplied air pressure to the pump. Check the compressor and regulator settings and check that the configuration of the air piping is correct.
	Cavitation occurs	Adjust the correlation between supply air pressure inlet and discharge flow or pressure, or shorten the suction lift length.
	Chattering occurs (ball valves not seating properly)	Check and adjust the correlation between supplied air pressure and inlet pressure and discharge pressure or flow. Decrease the inlet flow rate or increase the back pressure by slightly closing the discharge valve. Check the ball valve material is sufficiently heavy compared to the liquid being pumped.
	Icing on air-switching portion	Check that the air filter and exhaust are clean and not blocked or restricted. Check and adjust the air flow rate and the correlation between the liquid flow rates. Fit a speed control muffler. Manually remove ice from air-switching valve before restarting.
	The exhaust port (silencer) of pump is clogged with sludge. Or the air filter is blocked	Check and clean the exhaust port or replace the silencer. Check and replace the air filter as necessary.

Maintenance

Troubleshooting

Problem	Probable Cause	Actions to be taken
Liquid leakage from exhaust port (silencer)	The diaphragm is damaged	Disassemble and check the pump and replace the diaphragm.
	The fastening nuts for the center disk are loose	Disassemble and check the pump. Tighten the nuts.
Air is mixed into the liquid	The diaphragm is perforated cut or torn	Disassemble and check the pump check and replace the diaphragms as necessary.
	The center disk fastening nuts are loose	Disassemble and check the pump. Tighten the nuts.
	The diaphragm is not seated correctly within the chambers or the O-ring is missing	Check the positioning of the diaphragm is correct, and check the diaphragm is not deformed due to under torque of the chamber bolts. Check the O-ring is not missing or damaged and replace as necessary. Re-Torque the chamber bolts t the correct value.
	Air leak on (inlet) suction side	Check that inlet hose or hose fittings are not loose or broken and the pump manifold torque values are correct. Check the Inlet manifold O-rings are not damaged or missing.
Irregular noise	The supply air pressure is too high	Lower the supply air pressure to the pump. (Check the compressor and the configuration of air piping.)
	The spool oscillates and ball chattering occurs	Adjust the supply air pressure and discharge pressure. Reduce inlet flow valve to adjusting liquid pressure and volume.
	The pump is clogged with sludge with particles of larger than the permissible diameter	Disassemble the casing, check and clean.
Irregular vibration	The supply air pressure is too high	Lower the supply air pressure to the pump. (Check the compressor and the configuration of air piping.)
	The spool oscillates, and occur ball chattering	Adjust the supply air pressure and discharge pressure. Reduce inlet flow valve to adjusting liquid pressure and volume.
	Connection parts and pump mounting are loose	Check each connection part and tighten the bolts.

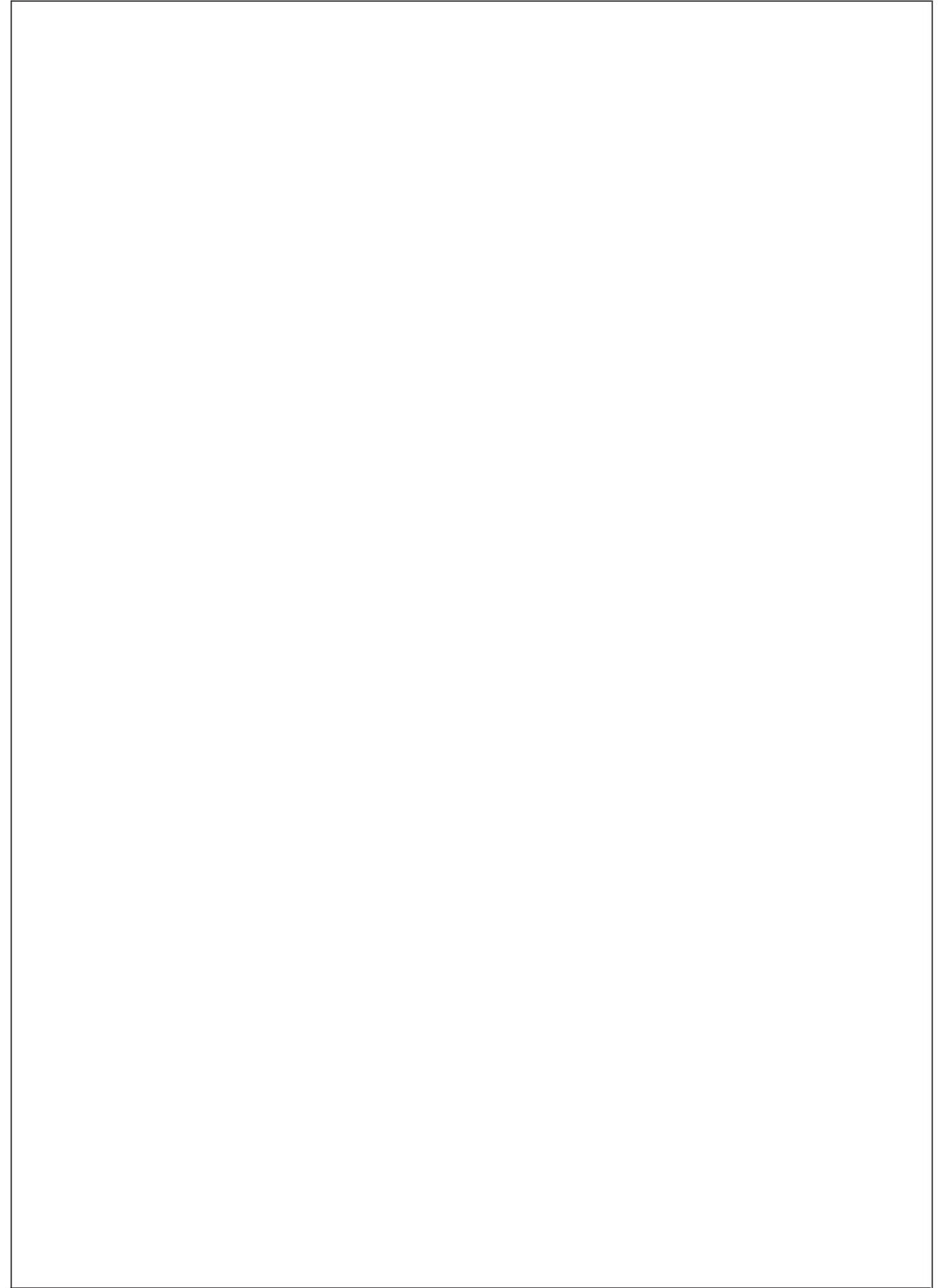
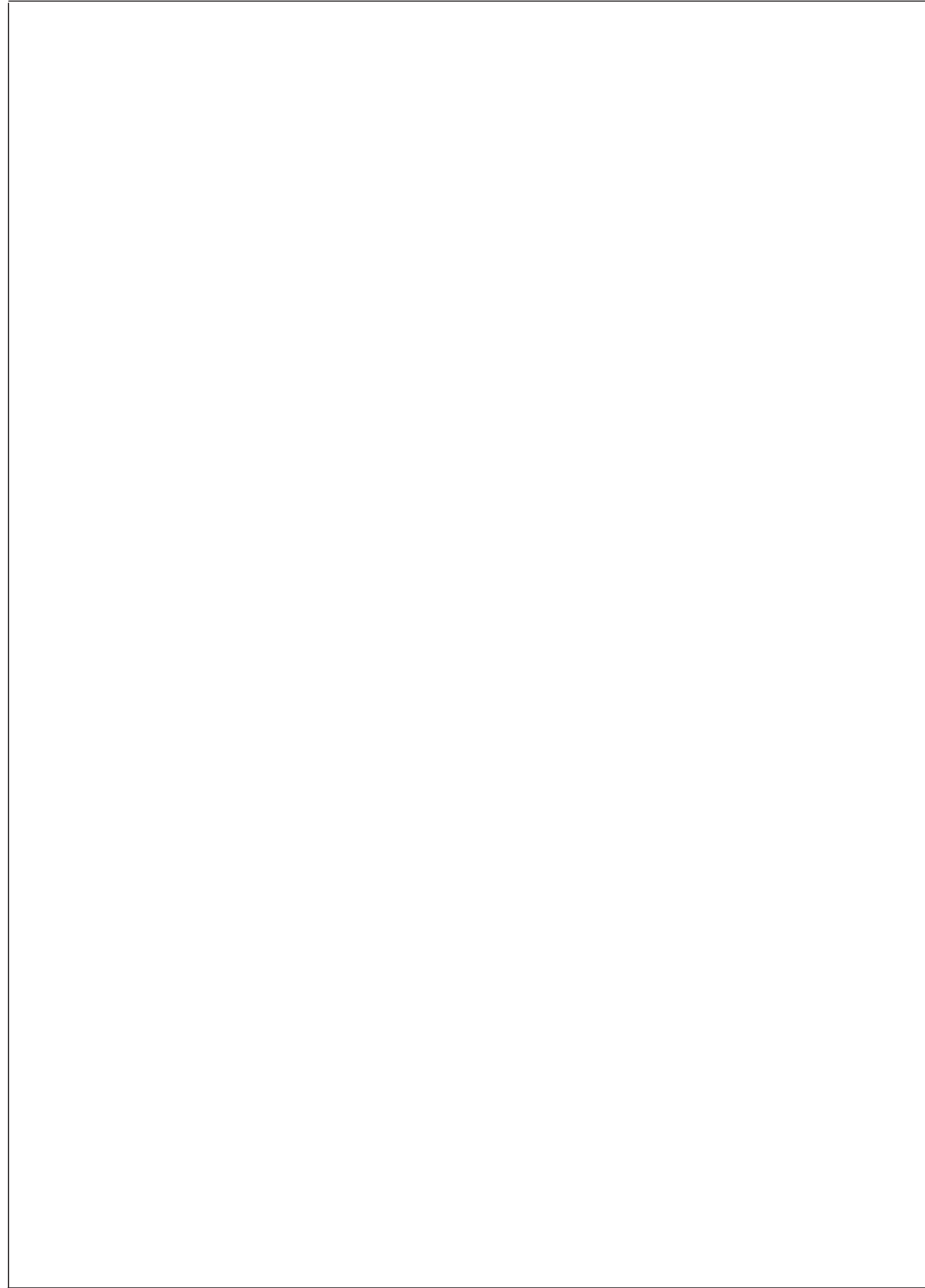

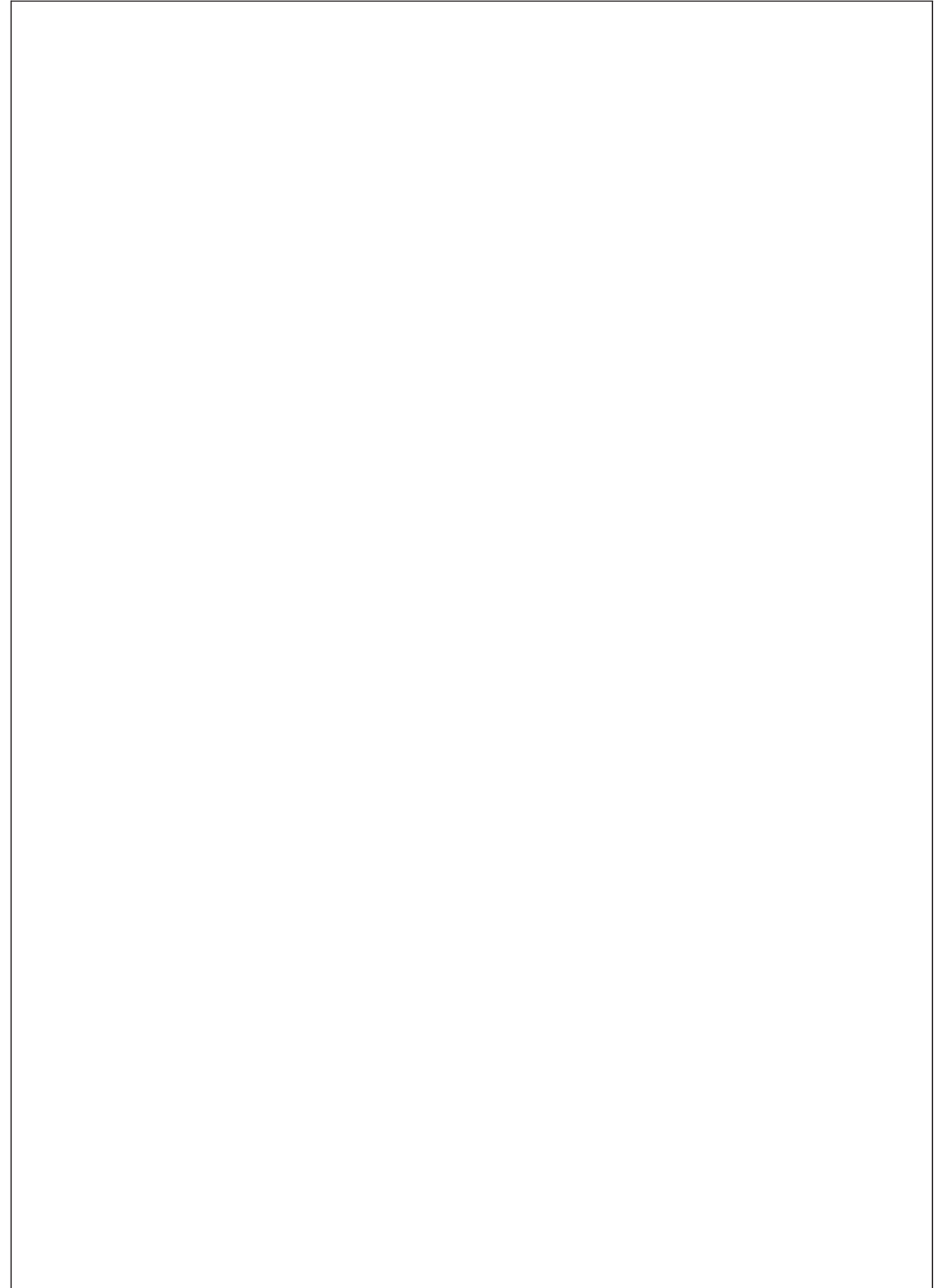
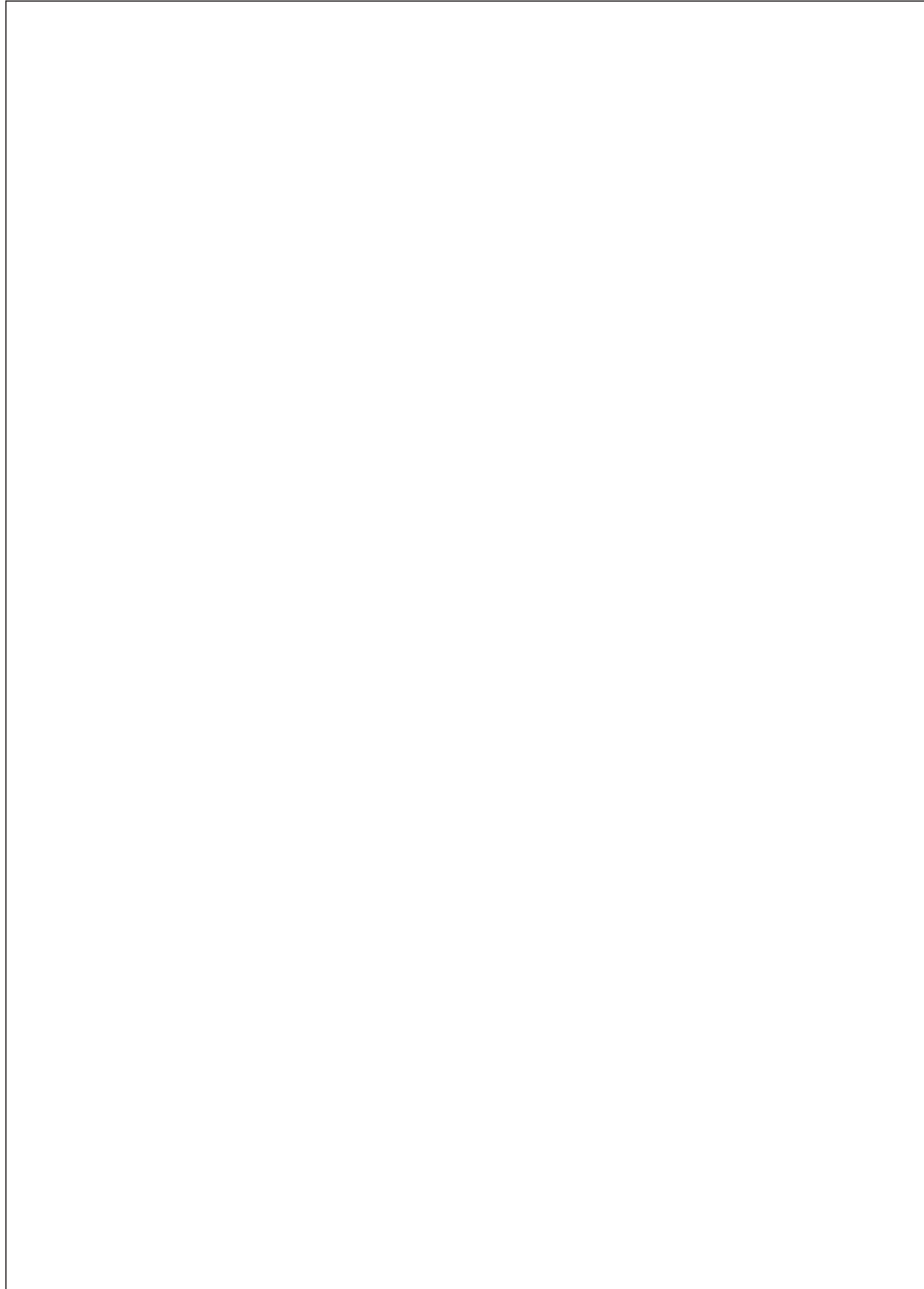

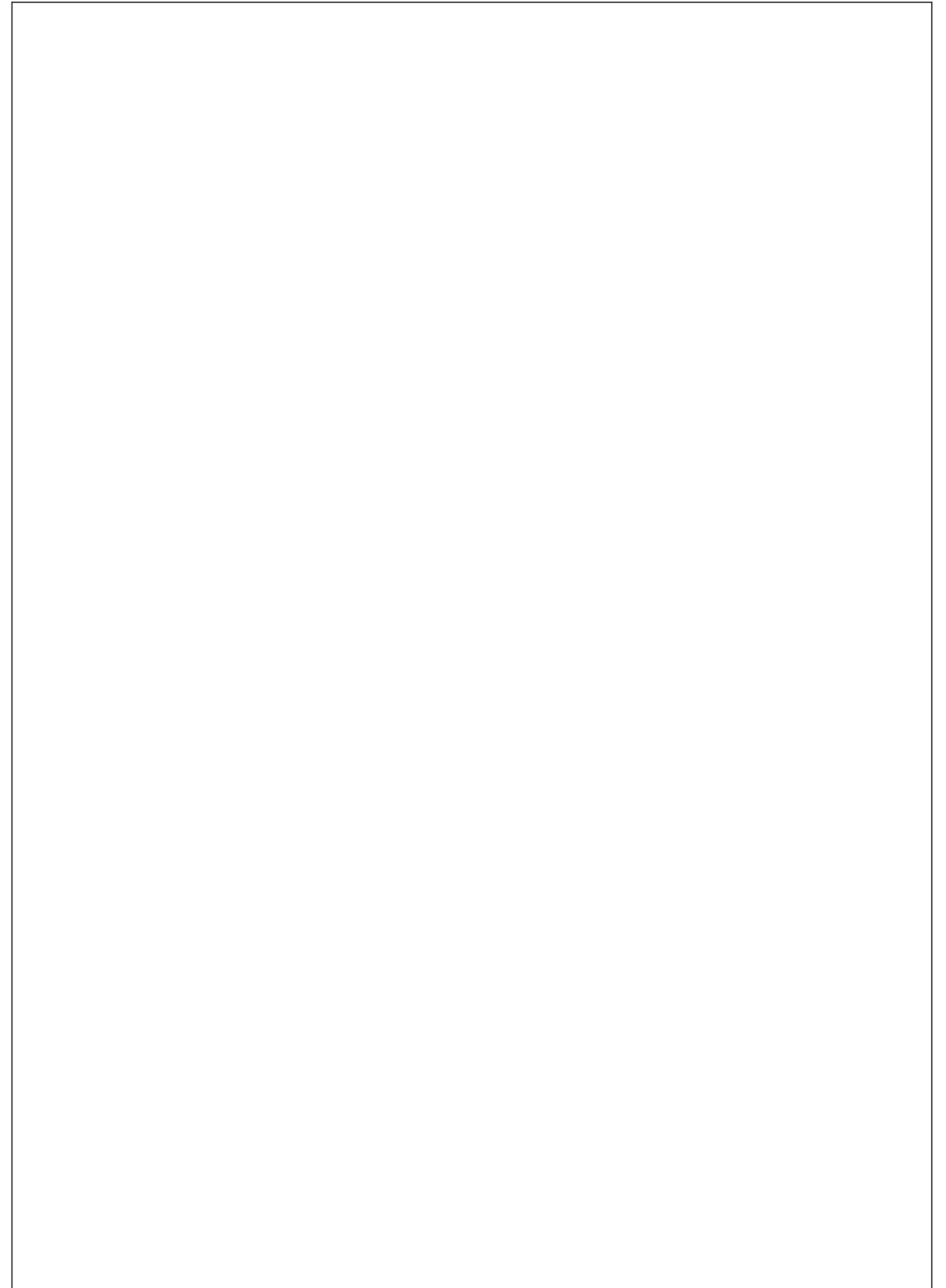
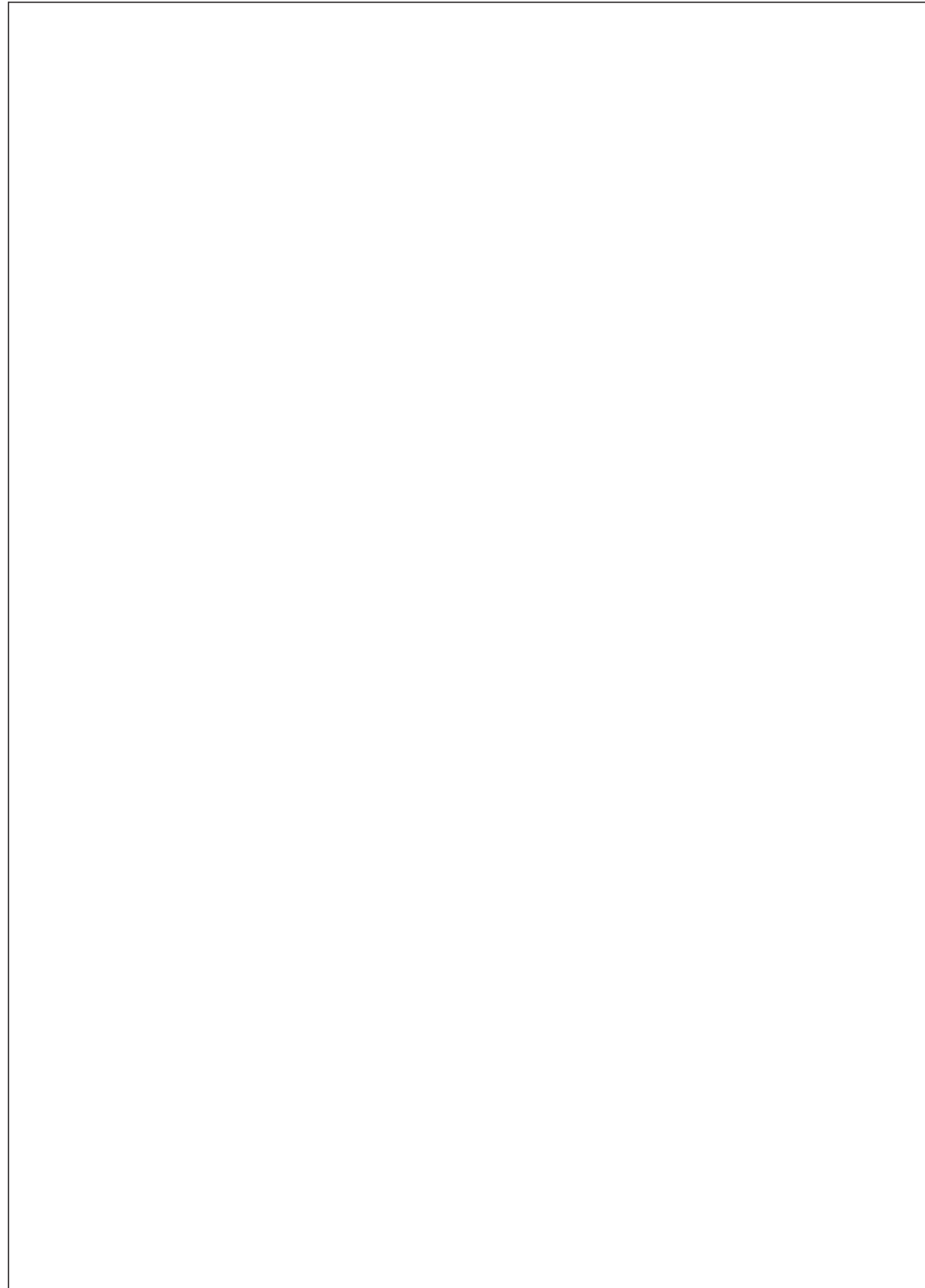

EC Declaration of Conformity ATEX 100a



This declaration applies to specified YTS Manufactured Air Operated Double Diaphragm pumps for Use In Potentially Explosive Atmospheres.

Products Manufactured By: **YTS Co Ltd.**
598-10 Monoi, Yotsukaido-City, Chiba, Japan, 284-0012.
Phone: +81 (0)43 310 6606
Fax: +81 (0)43 424 8977
E-Mail: sales@yts-pump.com
Web: yts-pump.com

Products: **Iwaki TC-X Air Operated Double Diaphragm Pumps**

Pump Models & Applicable Materials of Construction:

030 Series	PVDF
050 Series	AL, SUS, PVDF, POM, CFPP
101 Series	AL, SUS
150 Series	POM
151 Series	AL, SUS, PVDF, POM
152-PC Series	CFPP, AL, SUS, PVDF, POM * With CFPP Air Motor
202-PC Series	PVDF * With CFPP Air Motor
203-PC Series	AL, SUS * With CFPP Air Motor
203-MT Series	AL, SUS * With Metallic Air Motor
252-PC Series	CFPP, PVDF * With CFPP Air Motor
253-PC Series	AL, SUS, FE * With CFPP Air Motor
253-MT Series	AL, SUS, FE * With Metallic Air Motor
400 / 401 Series	AL, SUS, FE, PVDF
500 Series	AL, SUS, FE, PVDF *Except T, S & H Diaphragms.
500-HB	*PTFE Fitted 500 Series Pumps with Conductive TPEE back up.
800 Series	AL, SUS, FE *Except T, S & H Diaphragms.
800-HB	*PTFE Fitted 800 Series Pumps with Conductive TPEE back up.
TTC Series	CFPTFE

Special Option Models: If manufactured from the above listed materials:
Drum Pump Range, FDA Pump Range, High Pressure Pump Range.

Complies with the following Directives: Machinery Safety Directive:
2006/42/EC

Have used the following harmonized standards to verify conformance: Pumps & Pump Units for Liquids:
EN809

Non-electrical equipment for potentially explosive atmospheres : Internal control of production.
EN13463-1 : 2009

Non-electrical equipment intended for use in potentially explosive atmospheres: Protection by constructional safety "c"
EN13463-5 : 2011

Official Importer / Distributor within the EU: **YTS Pump Engineering BV.**
47-49 Vlijtstraat, Doetinchem, 7005 BN, the Netherlands
Phone: +31 (0)857607060. Mobile: +31 (0)623707959
E-mail 1: info@yts-pumps.com E-mail 2: g.heikens@yts-pumps.com

YTS Co Ltd. declares that the products listed herein conform to the relevant provisions of EC directive 94/9/EC of 23 March 1994 for equipment and protective systems intended for use in potentially explosive atmospheres, and is self-certified for safe use in Atex Group II, Category 2 areas.

Approved By:  **December 1st 2017**

Shigiru Murata
Director Quality & Engineering
YTS Co Ltd.

YTS YTS Quality System Registration: ISO 9001 Ver. 2015



EC DECLARATION OF CONFORMITY

Declaration of Conformity * Déclaration de Conformité * Declaración de Conformidad * Erklärung Bezüglich * Einhaltung Der Vorschriften * Dichiarazione di Conformità * Conformiteitsverklaring *

Products Manufactured By:	YTS Co Ltd. 598-10 Monoi, Yotsukaido-City, Chiba, Japan, 284-0012 Phone: +81 (0)43 310 6606 Fax: +81 (0)43 424 8977 E-Mail: sales@yts-pump.com Web: yts-pump.com
Products:	Air Operated Double Diaphragm Pumps
Models:	TC-X Series Diaphragm Pumps TC-X Series Diaphragm Pump Special Options
Complies with the following European Community Directives:	Machinery Safety Directive: 2006/42/EC
Have used the following harmonized standards to verify conformance:	Pumps & Pump Units for Liquids: EN12162: 2010 EN809 1998 A1: 2009 AC: 2010

Technical File Prepared By:

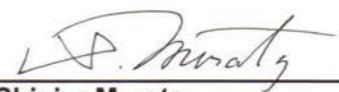
Shigiru Murata
Director Quality & Engineering

YTS Co Ltd.
598-10 Monoi, Yotsukaido-City, Chiba,
Japan, 284-0012

Phone: +81 (0)43-424-0966
Fax: +81 (0)43-424-8977
Email: murata@y-t-s.co.jp
Web: www.yts-pump.com

CE Authorized Representative:

Gerard Heikens
Managing Director

YTS Pump Engineering BV.
47-49 Vlijtstraat, Doetinchem, 7005 BN,
The Netherlands

Phone: +31 857607060
Email: g.heikens@yts-pumps.com

Date: April 1st 2015



